



ASSAM STATE ELECTION COMMISSION  
ADITYA TOWER, 2<sup>ND</sup> FLOOR, G. S. ROAD, DISPUR, GUWAHATI - 781006.  
Ph. No. 0361-2263210/2264920 e-mail - secassam@gmail.com

**NOTIFICATION**

Dated Dispur, 29<sup>th</sup> April, 2022

No. SEC. 39/2022/1 : As per provision of Rule 138 of the Assam Autonomous Districts (Constitution of District Council), Rules, 1951 read with Election Symbols (Reservation and Allotment) Order, 1968 of Election Commission of India (ECI), the following 'Reserved' and 'Free' symbols are hereby notified to be used by the contesting candidates in the ensuing Karbi Anglong Autonomous Council Election, 2022. The 'Reserved' symbols should be allowed only if the candidate is sponsored by National/ State Party having the specific symbol already allotted to it by the Election Commission of India.

**A. Reserved Symbols for National Parties:**

- |    |                               |   |   |
|----|-------------------------------|---|---|
| 1. | All India Trinamool Congress  | - | Flower & Grass  |
| 2. | Bahujan Samaj Party           | - | Shall select a free symbol as the Symbol 'Elephant' is reserved for AGP by the Election Commission of India |
| 3. | Bharatiya Janata Party        | - | Lotus   |
| 4. | Communist Party of India      | - | Ears of Corn and Sickle   |
| 5. | Communist Party of India (M)- | - | Hammer, Sickle and Star   |
| 6. | Indian National Congress      | - | Hand  |
| 7. | Nationalist Congress Party    | - | Clock   |
| 8. | National People's Party       | - | Book  |

**B. Reserved Symbols for State Parties:**

- |    |                                    |   |                       |
|----|------------------------------------|---|-----------------------|
| 1. | All India United Democratic Front- | - | Lock & Key            |
| 2. | Asom Gana Parishad                 | - | Elephant              |
| 3. | Bodoland Peoples Front             | - | Nangol                |
| 4. | United People's Party Liberal      | - | Tractor Chalata Kisan |

**C. Free Symbols: List enclosed at Annexure- I**

The allotment of free symbols shall be made in accordance with the Assam Autonomous Districts (Constitution of District Council), Rules, 1951 read with Election Symbols (Reservation and Allotment) Order, 1968 of Election Commission of India (ECI).

Images of the Symbols reserved for National/ State Parties and Free Symbols are enclosed at **Annexure- II and III**.

*Sd/-*

(Alok Kumar)

State Election Commissioner, Assam

Dispur :: Guwahati-6

Dated Dispur, 29<sup>th</sup> April, 2022

Memo No. SEC.39/2022/1 -A

Copy for kind information to:

1. The Additional Chief Secretary to the Government of Assam, Hill Areas Department, Dispur, Guwahati-6.
2. The Commissioner & Secretary to the Hon'ble Governor of Assam, Raj Bhawan, Kharghuli, Guwahati.

3. The S.O. to the Chief Secretary, Assam for kind information of Chief Secretary.
4. The Deputy Commissioner, Karbi Anglong, Diphu/West Karbi Anglong, Hamren. They will please furnish a copy of the list of symbols alongwith copy of nomination form while collected by the candidates.
5. The Sub-Divisional Officer (C), Bokajan. He will please furnish a copy of the list of symbols alongwith copy of nomination form while collected by the candidates.
6. The Principal Secretary, Karbi Anglong Autonomous Council, Diphu.
7. The Director, Information & Public Relations, Assam for wide publicity of the notification.
8. The Director, Printing & Stationery, Assam, Bamunimaidan, Guwahati-21. He is requested to kindly publish this notification in the official Gazette.
9. All Political Parties.

  
Secretary  
Assam State Election Commission  
Dispur :: Guwahati-06







**Annexure-I**List of Free Symbols





1	Air Conditioner	50	Cup & Saucer
2	Almirah	51	Cutting Pliers
3	Auto-Rickshaw	52	Diamond
4	Baby Walker	53	Diesel Pump
5	Ballon	54	Dish Antenna
6	Bangles	55	Dolli
7	Basket Containing Fruits	56	Door Bell
8	Bat	57	Door Handle
9	Batsman	58	Dril Machine
10	Battery Torch	59	Dumbbells
11	Bead Necklace	60	Ear Rings
12	Belt	61	Electric Pole
13	Bench	62	Envelope
14	Bicycle Pump	63	Extension Board
15	Binoculars	64	Flute
16	Biscuit	65	Football Player
17	Black Board	66	Fountain
18	Boat with Man and Sail	67	Frock
19	Box	68	Frying Pan
20	Bread	69	Funnel
21	Bread Toaster	70	Ganna Kisan
22	Bricks	71	Gas Cylinder
23	Brief Case	72	Gas Stove
24	Brush	73	Gift pack
25	Bucket	74	Ginger
26	Cake	75	Glass Tumbler
27	Calculator	76	Gramophone
28	Camera	77	Grapes
29	Can	78	Green chilli
30	Capsicum	79	Hand Cart
31	Carpet	80	Harmonium
32	Carron Board	81	Hat
33	Cauliflower	82	Head Phone
34	CCTV Camera	83	Helicopter
35	Chain	84	Helmet
36	Chakki	85	Hocket and Ball
37	Chapati Roller	86	Hour Glass
38	Chappals	87	Ice Cream
39	Chess Board	88	Immersion Rod
40	Chimney	89	Iron
41	Clip	90	Jackfruit
42	Coat	91	Kitchen Sink
43	Coconut Farm	92	Lady finger
44	Colour Tray & Brush	93	Laptop
45	Computer	94	Latch
46	Computer Mouse	95	Letter Box
47	Cot	96	Lighter
48	Crane	97	Ludo
49	Cube	98	Lunch Box

99	Man Blowing Turha	150	Spanner
100	Matchbox	151	Stapler
101	Mike	152	Stethoscope
102	Mixee	153	Stool
103	Nail Cutter	154	Stumps
104	Neck Tie	155	Swing
105	Noodles Bowl	156	Switchboard
106	Pan	157	Syringe
107	Pants	158	T.V Remote
108	Peanuts	159	Table
109	Pears	160	Tea Filter
110	Peas	161	Telephone
111	Pen drive	162	Television
112	Pen Nib with Seven Rays	163	Tennis Racket & Ball
113	Pen Stand	164	Tent
114	Pencil Box	165	Throwing a Javelin
115	Pencil Sharpener	166	Tiller
116	Pendulam	167	Toffees
117	Pestle and Mortar	168	Tongs
118	Petrol Pump	169	Tooth Brush
119	Phone Charger	170	Tooth Paste
120	Pillow	171	Tray
121	Pineapple	172	Triangle
122	Plastering Trowel	173	Truck
123	Plate Containing Food	174	Trumpet
124	Plate Stand	175	Tube Light
125	Pot	176	Typewriter
126	Pressure Cooker	177	Tyres
127	Punching Machine	178	Vacuum Cleaner
128	Razor	179	Violin
129	Refrigerator	180	Walking Stick
130	Ring	181	Wall Hook
131	Road Roller	182	Wallet
132	Robot	183	Walnut
133	Room Cooler	184	Water Melon
134	Room Heater	185	Water Tank
135	Rubber Stamp	186	Well
136	Safety Pin	187	Wheel Barrow
137	Saw	188	Whistle
138	School Bag	189	Window
139	Scissors	190	Winnower
140	Sewing Machine	191	Wool and Needle
141	Ship	192	Nagrik
142	Shoe	193	Dustbin
143	Shutter	194	A Boy and A Girl
144	Sitar	195	A Bunch of Paddy
145	Skipping Rope	196	Arrow on the Bow
146	Slate	197	An eye
147	Soap dish	198	Banana Tree
148	Socks	199	Bottle
149	Sofa	200	Butterfly

201	Cart
202	Deer
203	Dhenki
204	Duck
205	Egg on the Basket
206	Fish
207	Lantern
208	Open Umbrella
209	Pen and Ink Pot
210	Pig
211	Rising Sun
212	Tiger



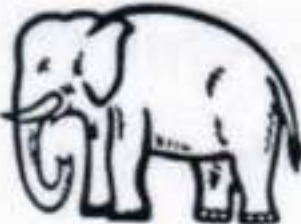



**Symbols Reserved for National and State Parties**

Sl. No.	Name of Political Party	Symbol
1.	All India Trinamool Congress	 <p align="center"><b>Flower &amp; Grass</b></p>
2.	Bahujan Samaj Party	<p>Shall select a free symbol as the Symbol Elephant is reserved for AGP by the Election Commission of India</p>
3.	Bharatiya Janata Party	 <p align="center"><b>Lotus</b></p>
4.	Communist Party of India	 <p align="center"><b>Ears of Corn &amp; Sickle</b></p>
5.	Communist Party of India (Marxist)	 <p align="center"><b>Hammer, Sickle and Star</b></p>
6.	Indian National Congress	 <p align="center"><b>Hand</b></p>
7.	Nationalist Congress Party	





		<b>Clock</b>
8.	National People's Party	
9.	All India United Democratic Front	 <b>Lock &amp; Key</b>
10.	Asom Gana Parishad	 <b>Elephant</b>
11	Bodoland Peoples Front	 <b>Nangol</b>
12	United People's Party Liberal	 <b>Tractor Chalata Kishan</b>







**Annexure-III**

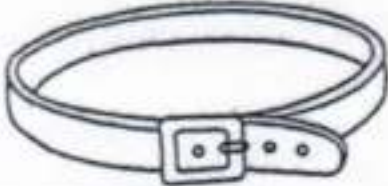
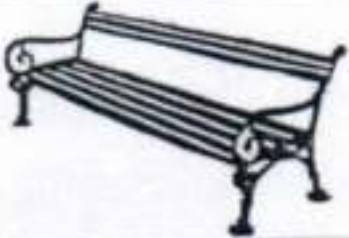
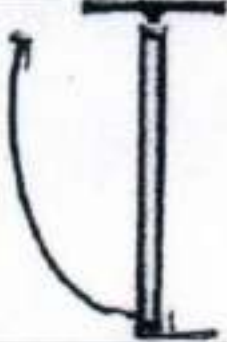





**KAAC Election, 2022**  
**(IMAGES OF FREE SYMBOLS)**

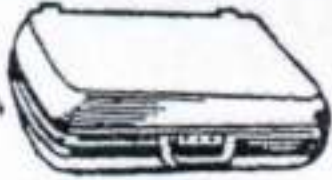

SLNo	Symbol	Image
1.	Air Conditioner	
2.	Almirah	
3.	Auto-Rickshaw	
4.	Baby Walker	
5.	Balloon	
6.	Bangles	
7.	Basket containing Fruits	









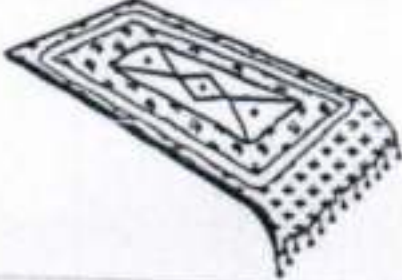
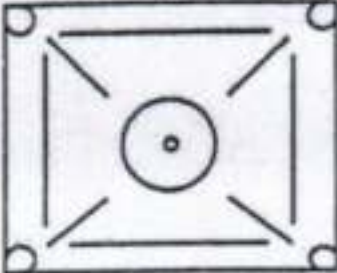



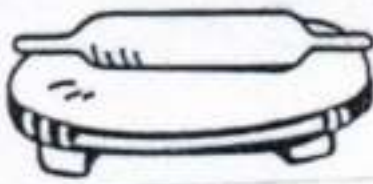

8.	Bat	
9.	Batsman	
10.	Battery Torch	
11.	Bead Necklace	
12.	Belt	
13.	Bench	
14.	Bicycle Pump	







15.	<b>Binoculars</b>	
16.	<b>Biscuit</b>	
17.	<b>Black Board</b>	
18.	<b>Boat with Man and Sail</b>	
19.	<b>Box</b>	
20.	<b>Bread</b>	
21.	<b>Bread Toaster</b>	



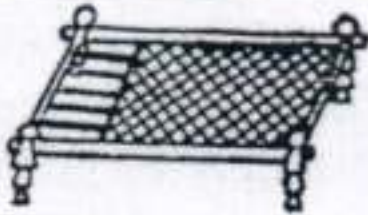

22.	Bricks	
23.	Brief Case	
24.	Brush	
25.	Bucket	
26.	Cake	
27.	Calculator	
28.	Camera	

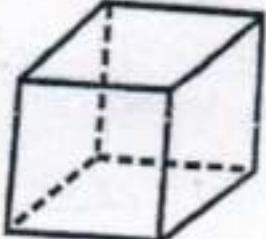
29.	Can	
30.	Capsicum	
31.	Carpet	
32.	Carrom Board	



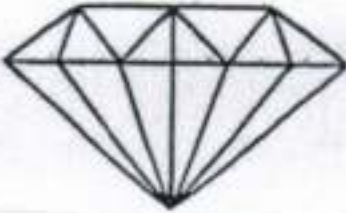

33.	Cauliflower	
34.	CCTV Camera	
35.	Chain	
36.	Chakki	
37.	Chapati Roller	
38.	Chappals	



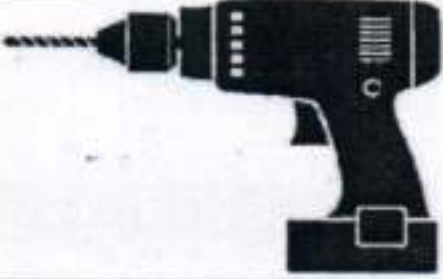

39.	Chess Board	
40.	Chimney	
41.	Clip	
42.	Coat	
43.	Coconut Farm	
44.	Colour Tray & Brush	

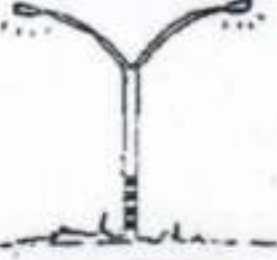



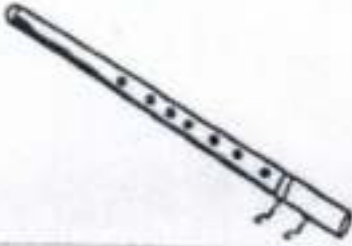

45.	<b>Computer</b>	
46.	<b>Computer Mouse</b>	
47.	<b>Cot</b>	
48.	<b>Crane</b>	
49.	<b>Cube</b>	
50.	<b>Cup &amp; Saucer</b>	





51.	Cutting Pliers	
52.	Diamond	
53.	Diesel Pump	
54.	Dish Antenna	
55.	Dolli	
56.	Door Bell	











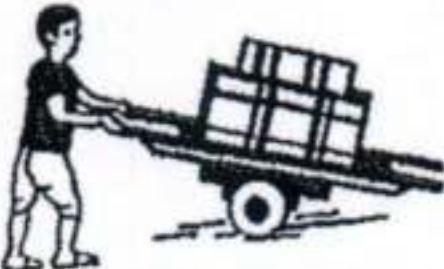
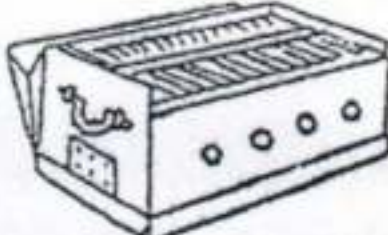

57.	<b>Door Handle</b>	
58.	<b>Drill Machine</b>	
59.	<b>Dumbbells</b>	
60.	<b>Ear Rings</b>	
61	<b>Electric Pole</b>	
62	<b>Envelope</b>	







63.	Extension Board	
64.	Flute	
65.	Football Player	
66.	Fountain	
67.	Frock	
68.	Frying Pan	





69.	Funnel	
70.	Ganna Kisan	
71.	Gas Cylinder	
72.	Gas Stove	
73.	Gift Pack	
74.	Ginger	

75.	<b>Glass Tumbler</b>	
76.	<b>Gramophone</b>	
77.	<b>Grapes</b>	
78.	<b>Green Chilli</b>	



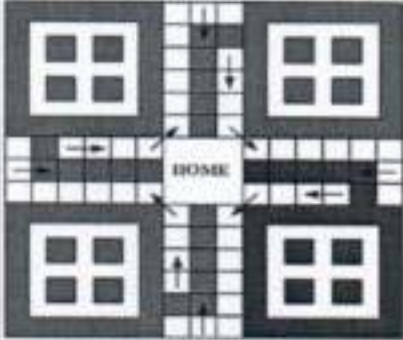



79.	Hand Cart	
80.	Harmonium	
81.	Hat	
82.	Head Phone	
83.	Helicopter	







84.	<b>Helmet</b>	
85.	<b>Hockey and Ball</b>	
86.	<b>Hour Glass</b>	
87.	<b>Ice Cream</b>	
88.	<b>Immersion Rod</b>	
89.	<b>Iron</b>	







90.	<b>Jackfruit</b>	
91.	<b>Kitchen Sink</b>	
92.	<b>Lady Finger</b>	
93.	<b>Laptop</b>	
94.	<b>Latch</b>	
95.	<b>Letter Box</b>	





96.	Lighter	
97.	Ludo	
98.	Lunch Box	
99.	Man Blowing Turha	
100.	Matchbox	









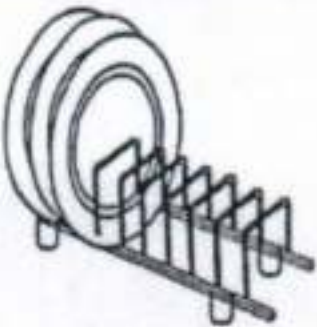

101.	<b>Mike</b>	
102.	<b>Mixee</b>	
103.	<b>Nail Cutter</b>	
104.	<b>Neck Tie</b>	
105.	<b>Noodles Bowl</b>	
106.	<b>Pan</b>	



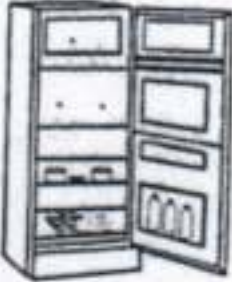

107.	<b>Pants</b>	
108.	<b>Peanuts</b>	
109.	<b>Pears</b>	
110.	<b>Peas</b>	
111.	<b>Pen Drive</b>	
112.	<b>Pen Nib with Seven Rays</b>	



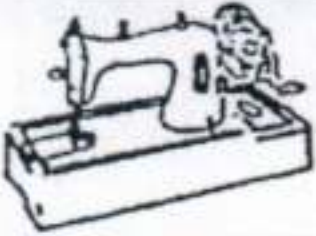

113.	<b>Pen Stand</b>	
114.	<b>Pencil Box</b>	
115.	<b>Pencil Sharpener</b>	
116.	<b>Pendulum</b>	
117.	<b>Pestle and Mortar</b>	
118.	<b>Petrol Pump</b>	

119.	<b>Phone Charger</b>	
120.	<b>Pillow</b>	
121.	<b>Pineapple</b>	
122.	<b>Plastering Trowel</b>	
123.	<b>Plate Containing Food</b>	
124.	<b>Plate Stand</b>	





125.	Pot	
126.	Pressure Cooker	
127.	Punching Machine	
128.	Razor	
129.	Refrigerator	
130.	Ring	
131.	Road Roller	





132.	<b>Robot</b>	
133.	<b>Room Cooler</b>	
134.	<b>Room Heater</b>	
135.	<b>Rubber Stamp</b>	
136.	<b>Safety Pin</b>	
137.	<b>Saw</b>	





138.	School Bag	
139.	Scissors	
140.	Sewing Machine	
141.	Ship	
142.	Shoe	

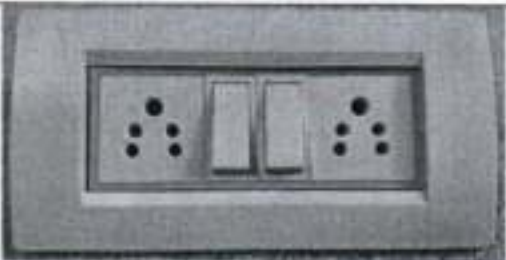



143.	<b>Shutter</b>	
144.	<b>Sitar</b>	
145.	<b>Skipping Rope</b>	
146.	<b>Slate</b>	
147.	<b>Soap Dish</b>	

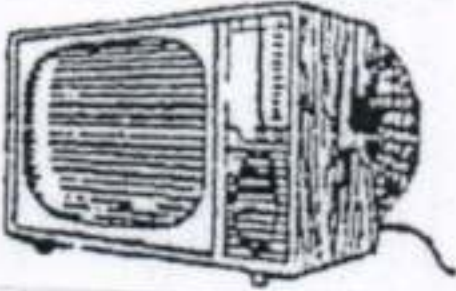

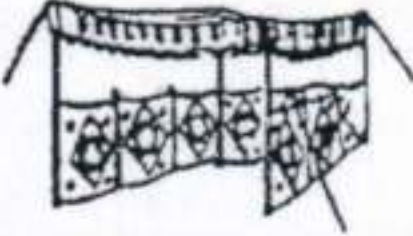









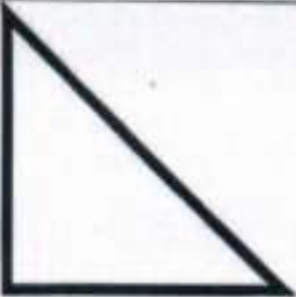

148.	<b>Socks</b>	
149.	<b>Sofa</b>	
150.	<b>Spanner</b>	
151.	<b>Stapler</b>	
152.	<b>Stethoscope</b>	





153.	<b>Stool</b>	
154.	<b>Stumps</b>	
155.	<b>Swing</b>	
156.	<b>Switchboard</b>	
157.	<b>Syringe</b>	
158.	<b>T.V.Remote</b>	





159.	<b>Table</b>	
160.	<b>Tea Filter</b>	
161.	<b>Telephone</b>	
162.	<b>Television</b>	
163.	<b>Tennis Racket &amp; Ball</b>	
164.	<b>Tent</b>	

165.	<b>Throwing a Javelin</b>	
166.	<b>Tiller</b>	
167.	<b>Toffees</b>	
168.	<b>Tongs</b>	
169.	<b>Tooth Brush</b>	



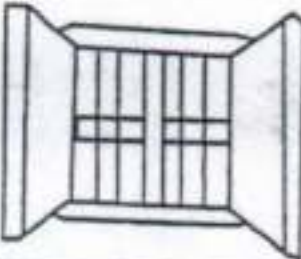

170.	<b>Tooth Paste</b>	
171.	<b>Tray</b>	
172.	<b>Triangle</b>	
173.	<b>Truck</b>	
174.	<b>Trumpet</b>	
175.	<b>Tube light</b>	





176	Typewriter	
177	Tyres	
178	Vacuum Cleaner	
179	Violin	
180	Walking Stick	
181	Wall Hook	
182	Wallet	





183	Walnut	 A black and white photograph showing three walnuts. One is whole, and two are cracked open, revealing the nutmeats.
184	Water Melon	 A black and white photograph of a watermelon. One slice has been cut out and is placed next to the whole melon.
185	Water Tank	 A black and white technical drawing of a cylindrical water tank. The top is covered with a flat roof supported by four vertical posts. There are several small circles on the top surface, possibly representing valves or access points.
186	Well	 A black and white illustration of a well. It features a circular opening in the ground surrounded by a brick or stone wall. A wooden frame with a roof is built over the opening, and a bucket is suspended from a pulley system.
187	Wheel Barrow	 A black and white photograph of a wheelbarrow. It has a single large wheel at the front and two handles at the back.

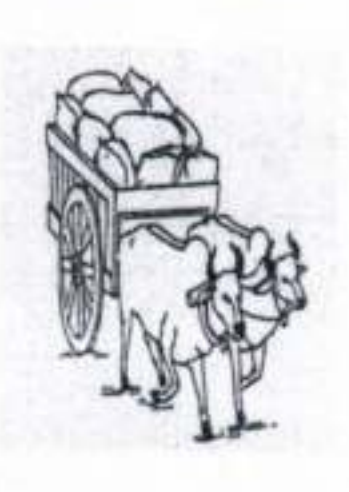



188	<b>Whistle</b>	
189	<b>Window</b>	
190	<b>Winnower</b>	
191	<b>Wool and Needle</b>	
192	<b>Nagrik</b>	
193	<b>Dustbin</b>	



194.	<b>A Boy and a Girl</b>	
195.	<b>A Bunch of Paddy</b>	
196.	<b>Arrow on the Bow</b>	
197.	<b>An Eye</b>	
198.	<b>Banana Tree</b>	

199.	<b>Bottle</b>	
200.	<b>Butterfly</b>	
201.	<b>Cart</b>	
202.	<b>Deer</b>	

203.	<b>Dhenki</b>	
204.	<b>Duck</b>	
205.	<b>Egg on the Basket</b>	
206.	<b>Fish</b>	
207.	<b>Lantern</b>	

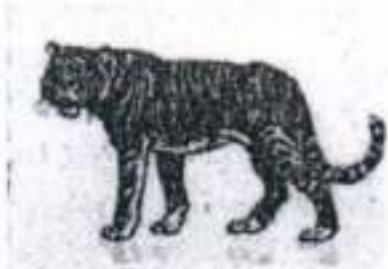
208.	<b>Open Umbrella</b>	 A simple black and white illustration of an open umbrella with a curved handle.
209.	<b>Pen and Ink Pot</b>	 A black and white illustration of a fountain pen and an ink bottle.
210.	<b>Pig</b>	 A simple black and white line drawing of a pig, facing right.
211.	<b>Rising Sun</b>	 A black and white illustration of a sun rising over a horizon line, with rays emanating from the sun.
212.	<b>Tiger</b>	 A black and white illustration of a tiger, shown in profile walking towards the left.